





PRESS - PACK RECTIFIER DIODE D233-800

<ul style="list-style-type: none">◆ $V_{RRM} = \underline{3400-4400\text{ V}}$◆ $I_{F(AV)} = \underline{920\text{ A}}$ ($T_C = 85^\circ\text{C}$)◆ $I_{FSM} = \underline{7,5\text{ kA}}$ ($t_p = 10\text{ms}$)		
<ul style="list-style-type: none">◆ Low forward losses◆ Low dispersion Q_{RR} and V_{FM} for series and parallel connections◆ Press-pack design		

MAXIMUM RATED VALUES

Parameter and conditions	Symbol	Values	Units
Repetitive peak reverse voltage, $T_j = -60 \dots +160\text{ }^\circ\text{C}$	V_{RRM}	3400-4400	V
Non- repetitive peak reverse voltage, $T_j = -60 \dots +160\text{ }^\circ\text{C}$	V_{RSM}	3500-4500	
Repetitive peak reverse current, $T_j = 160\text{ }^\circ\text{C}$, $V_R = V_{RRM}$	I_{RRM}	50	mA
Maximum average forward current, $T_C = 85\text{ }^\circ\text{C}$, $f = 50\text{ Hz}$	$I_{F(AV)}$	920	A
RMS forward current, $T_C = 85\text{ }^\circ\text{C}$, $f = 50\text{ Hz}$	I_{FRMS}	1440	
Surge non-repetitive current, $T_j = 160\text{ }^\circ\text{C}$, $V_R = 0$, $t_p = 10\text{ ms}$	I_{FSM}	7,5	kA
Safety factor	I^2t	$280 \cdot 10^3$	A^2s
Operation junction temperature range	T_j	-60 ... +160	$^\circ\text{C}$
Storage temperature range	T_{stg}	-60 ... +50	

**D233-800**

ELECTRICAL CHARACTERISTICS					
Parameter and conditions	Symbol	Values			Units
		min	typ.	max	
Maximum peak forward voltage, $T_j = 25\text{ °C}$, $I_F = 2500\text{ A}$	V_{FM}	-	-	2,30	V
On-state threshold voltage, $T_j = 160\text{ °C}$, $I_F = 1250 - 3750\text{ A}$	V_{TO}	-	-	0,90	
On-state slope resistance, $T_j = 160\text{ °C}$, $I_F = 1250 - 3750\text{ A}$	r_T	-	-	0,599	mΩ
Recovery charge, $T_j = 160\text{ °C}$, $I_F = 800\text{ A}$, $di_F/dt = -5\text{ A}/\mu\text{s}$, $V_R \geq 100\text{ V}$	Q_{RR}	-	-		μAs
Recovery current, $T_j = 160\text{ °C}$, $I_F = 800\text{ A}$, $di_F/dt = -5\text{ A}/\mu\text{s}$, $V_R \geq 100\text{ V}$	I_{RR}	-	-		A
THERMAL PARAMETERS					
Thermal resistance junction to case, DC per diode double side cooled anode side cooled cathode side cooled	$R_{th(j-c)}$	-	-	0,036 0,072 0,072	°C/W
Thermal resistance case to heatsink, double side cooled single side cooled	$R_{th(c-h)}$	-	-	0,015 0,030	
MECHANICAL PARAMETERS					
Weight	w	-	0,18	-	kg
Mounting force	F	9		10	kN
Maximum acceleration (at nominal mounting force)	a	-	-	100	m/s ²



D233-800

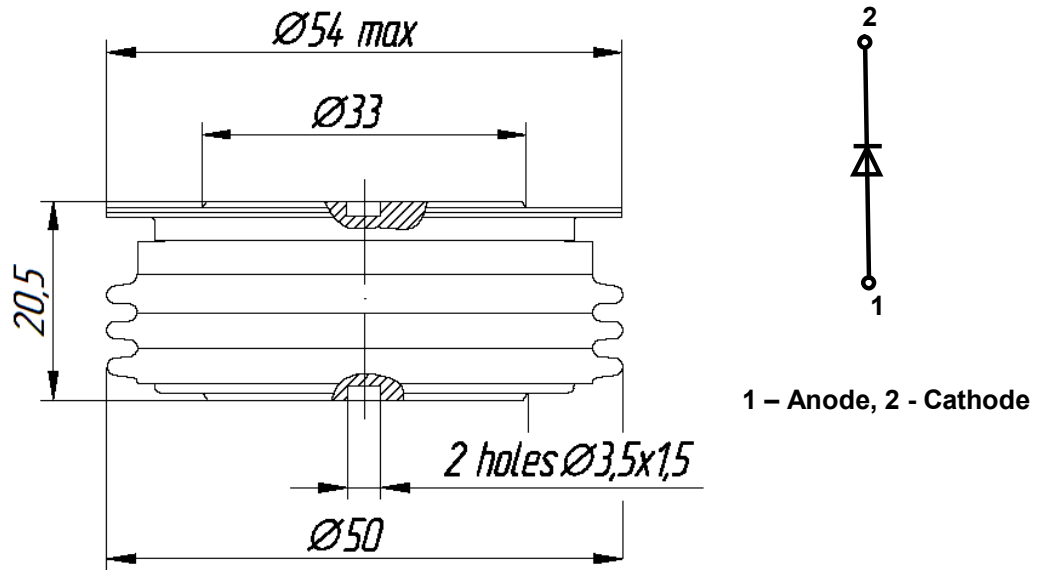

Fig. 1. Device Outline Drawing
(dimensions in mm)



126, Proletarskaya str.,
430001, Saransk, Republic Mordovia, Russia
Tel: +7(8342) 47-04-30
Tel/Fax: +7 (8342) 47-15-01
E-mail: vpruvs@elvpr.ru
Internet: www.elvpr.ru