



AVALANCHE RECTIFIER DIODE DA153-2000

<ul style="list-style-type: none"> ◆ $V_{RRM} = \underline{1600 - 2000 V}$ ◆ $I_{F(AV)} = \underline{2000 A}$ ($T_C = 100\text{ }^\circ\text{C}$) ◆ $I_{FSM} = \underline{30 kA}$ ($t_p = 10\text{ms}$) 		
<ul style="list-style-type: none"> ◆ High reability ◆ Guaranteed maximum avalanche power dissipation ◆ Press-pack design 		

MAXIMUM RATED VALUES

Parameter and conditions	Symbol	Values	Units
Repetitive peak reverse voltage, $T_j = -60 \dots +175\text{ }^\circ\text{C}$	V_{RRM}	1600-2000	V
Avalanche breakdown voltage, $T_j = -60 \dots +175\text{ }^\circ\text{C}$	V_{BR}	1800-2300	
Repetitive peak reverse current, $T_j = 175\text{ }^\circ\text{C}$, $V_R = V_{RRM}$	I_{RRM}	50	mA
Maximum average forward current, $T_C = 100\text{ }^\circ\text{C}$, $f = 50\text{ Hz}$	$I_{F(AV)}$	2000	A
RMS forward current, $T_C = 100\text{ }^\circ\text{C}$, $f = 50\text{ Hz}$	I_{FRMS}	3140	
Surge non-repetitive current, $T_j = 175\text{ }^\circ\text{C}$, $V_R = 0$, $t_p = 10\text{ ms}$	I_{FSM}	30	kA
Safety factor	I^2t	$4500 \cdot 10^3$	A^2s
Operation junction temperature range	T_j	-60 ... +175	°C
Storage temperature range	T_{stg}	-60 ... +50	

**DA153-2000**

ELECTRICAL CHARACTERISTICS					
Parameter and conditions	Symbol	Values			Units
		min	typ.	max	
Maximum peak forward voltage, $T_j = 25\text{ °C}$, $I_F = 6280\text{ A}$	V_{FM}	-	-	1,80	V
On-state threshold voltage, $T_j = 175\text{ °C}$, $I_F = 3100 - 9400\text{ A}$	V_{TO}	-	-	0,90	
On-state slope resistance, $T_j = 175\text{ °C}$, $I_F = 3100 - 9400\text{ A}$	r_T	-	-	0,185	mΩ
Rated reverse power dissipation, $T_j = 175\text{ °C}$, $t_p = 100\text{ мкс}$	P_{RSM}	-	-	16,0	kW
THERMAL PARAMETERS					
Thermal resistance junction to case, DC per diode double side cooled anode side cooled cathode side cooled	$R_{th(j-c)}$	-	-	0,020 0,040 0,040	°C/W
Thermal resistance case to heatsink, double side cooled single side cooled	$R_{th(c-h)}$	-	-	0,005 0,010	
MECHANICAL PARAMETERS					
Weight	w	-	0,55	-	kg
Clamping force	F	22	-	26	kN
Maximum acceleration (at nominal mounting torque)	a	-	-	100	m/s ²



DA153-2000

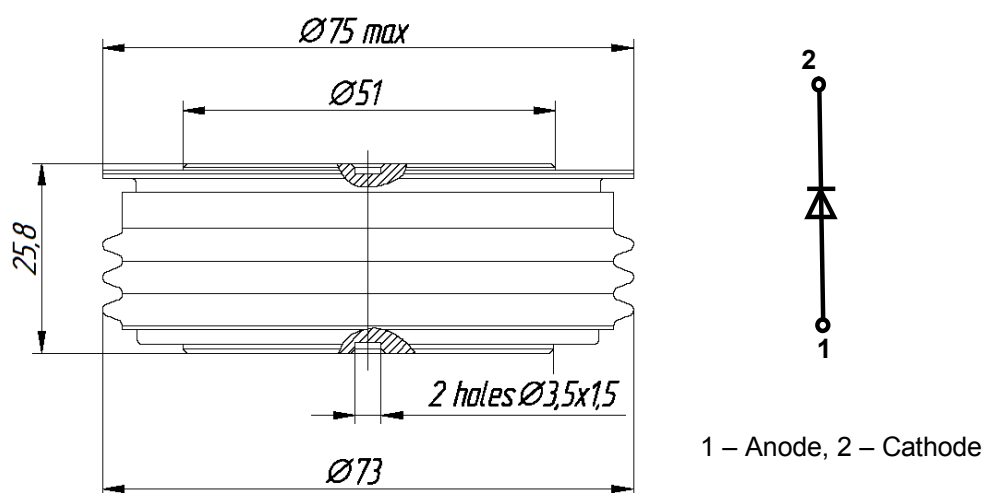

Fig. 1. Device Outline Drawing
(dimensions in mm)



126, Proletarskaya str.,
430001, Saransk, Republic Mordovia, Russia
Tel: +7(8342) 47-04-30
Tel/Fax: +7 (8342) 47-15-01
E-mail: vpruvs@elvpr.ru
Internet: www.elvpr.ru