

PHASE CONTROL THYRISTOR T293-4000

<ul style="list-style-type: none"> ◆ $V_{DRM} = \underline{1800 - 2800 V}$ ◆ $V_{RRM} = \underline{1800 - 2800 V}$ ◆ $I_{T(AV)} = \underline{5487 A}$ ($T_C = 70\text{ °C}$) ◆ $I_{T(AV)} = \underline{4430 A}$ ($T_C = 85\text{ °C}$) ◆ $I_{TSM} = \underline{90 kA}$ ($T_j = 125\text{ °C}$) 		
<ul style="list-style-type: none"> ◆ Amplifying gate ◆ Low on-state switching losses ◆ Acceptable for series and parallel connections ◆ Low dispersion Q_{rr}, V_{TM} 		

MAXIMUM RATED VALUES

Parameter and conditions	Symbol	Values	Units
Repetitive peak off-state voltage, $T_j = -60 \dots +125\text{ °C}$	V_{DRM}	1800 - 2800	V
Repetitive peak reverse voltage, $T_j = -60 \dots +125\text{ °C}$	V_{RRM}	1800 - 2800	
Non-repetitive peak off-state voltage, $T_j = -60 \dots +125\text{ °C}$	V_{DSM}	1900 - 2900	
Non-repetitive peak reverse voltage, $T_j = -60 \dots +125\text{ °C}$	V_{RSM}	1900 - 2900	
Repetitive peak off-state current/ Repetitive peak reverse current, $T_j = 125\text{ °C}$, $V_D / V_R = V_{DRM} / V_{RRM}$	I_{DRM} / I_{RRM}	300	mA
Average on-state current, $f = 50\text{ Hz}$, double side cooling, $T_C = 85\text{ °C}$ $T_C = 70\text{ °C}$	$I_{T(AV)}$	4430 5487	A
RMS on-state current, $T_C = 70\text{ °C}$, $f = 50\text{ Hz}$	I_{TRMS}	8614	A
Surge non-repetitive on-state current, $T_j = 125\text{ °C}$, $V_R = 0$, $t_p = 10\text{ ms}$	I_{TSM}	90	kA
Safety factor	I^2t	$4.1 \cdot 10^7$	A^2s
Critical rate of rise of on-state current, $T_j = 125\text{ °C}$, $V_D = 0.67V_{DRM}$, $I_T = 8000\text{ A}$, $I_{FG} = 2\text{ A}$, $t_r = 1\text{ }\mu s$, $f = 50\text{ Hz}$	$(di_T/dt)_{crit}$	200	$A/\mu s$
Critical rate of rise of off-state voltage, $T_j = 125\text{ °C}$, $V_D = 0.67V_{DRM}$	$(dv_D/dt)_{crit}$	1000 - 1600	$V/\mu s$
Gate power loss, DC	P_{GM}	4	W
Operation junction temperature range	T_j	-60... +125	°C
Storage temperature range	T_{stg}	-60... +50	



T293-4000

ELECTRICAL CHARACTERISTICS					
Parameter and conditions	Symbol	Values			Units
		min	typ.	max	
Peak on-state voltage, $T_j = 25\text{ °C}$, $I_T = 12570\text{ A}$	V_{TM}	-	-	1.45	V
On-state threshold voltage, $T_j = 125\text{ °C}$, $I_T = 6280 - 18840\text{ A}$	$V_{T(TO)}$	-	-	0.95	
On-state slope resistance, $T_j = 125\text{ °C}$, $I_T = 6280 - 18840\text{ A}$	r_T	-	-	0.075	mΩ
Delay time, $T_j = 25\text{ °C}$, $V_D = 0.50V_{DRM}$, $I_T = 4000\text{ A}$, $I_{FG} = 2\text{ A}$, $t_r = 0.5\text{ μs}$	t_d	-	-	4.0	μs
Turn off-time, $T_j = 125\text{ °C}$, $I_T = 4000\text{ A}$, $di_T/dt = -5\text{ A/μs}$, $V_R \geq 100\text{ V}$, $V_D = 0.67V_{DRM}$, $dv_D/dt = 50\text{ V/μs}$	t_q	-	400	-	
Reverse recovery charge, $T_j = 125\text{ °C}$, $I_T = 4000\text{ A}$, $di_T/dt = -5\text{ A/μs}$, $V_R \geq 100\text{ V}$	Q_{RR}	-	-	3500	μAs
Holding current, $T_j = 25\text{ °C}$, $V_D = 12\text{ V}$	I_H	-	-	300	mA
Latching current, $T_j = 25\text{ °C}$, $V_D = 12\text{ V}$, $I_{FG} = 2\text{ A}$, $t_r = 0.5\text{ μs}$	I_L	-	-	1500	
Gate trigger voltage, $V_D = 12\text{ V}$, $T_j = -60\text{ °C}$ $T_j = 25\text{ °C}$ $T_j = 125\text{ °C}$	V_{GT}	-	-	3.5 2.5 2.0	V
Gate trigger current, $V_D = 12\text{ V}$, $T_j = -60\text{ °C}$ $T_j = 25\text{ °C}$ $T_j = 125\text{ °C}$	I_{GT}	-	-	450 250 200	mA
Gate non-trigger direct voltage, $T_j = 125\text{ °C}$, $V_D = 0.67V_{DRM}$	V_{GD}	0.25	-	-	V
Gate non-trigger direct current, $T_j = 125\text{ °C}$, $V_D = 0.67V_{DRM}$	I_{GD}	15	-	-	mA
THERMAL PARAMETERS					
Thermal junction to case resistance, DC: double side cooled DC: anode side cooled DC: cathode side cooled	$R_{th(j-c)}$ $R_{th(j-cA)}$ $R_{th(j-cK)}$	-	-	0.0051 0.0102 0.0102	°C/W
Thermal case to heatsink resistance, double side cooled single side cooled	$R_{th(c-h)}$	-	-	0.0025 0.0050	
MECHANICAL PARAMETERS					
Weight	w	-	1.98	-	kg
Clamping force	F	80	-	100	kN
Maximum acceleration (at nominal mounting force)	a	-	-	100	m/s ²
Minimal gate-anode distance on insulator surface	D_s	-	33.5	-	mm



T293-4000

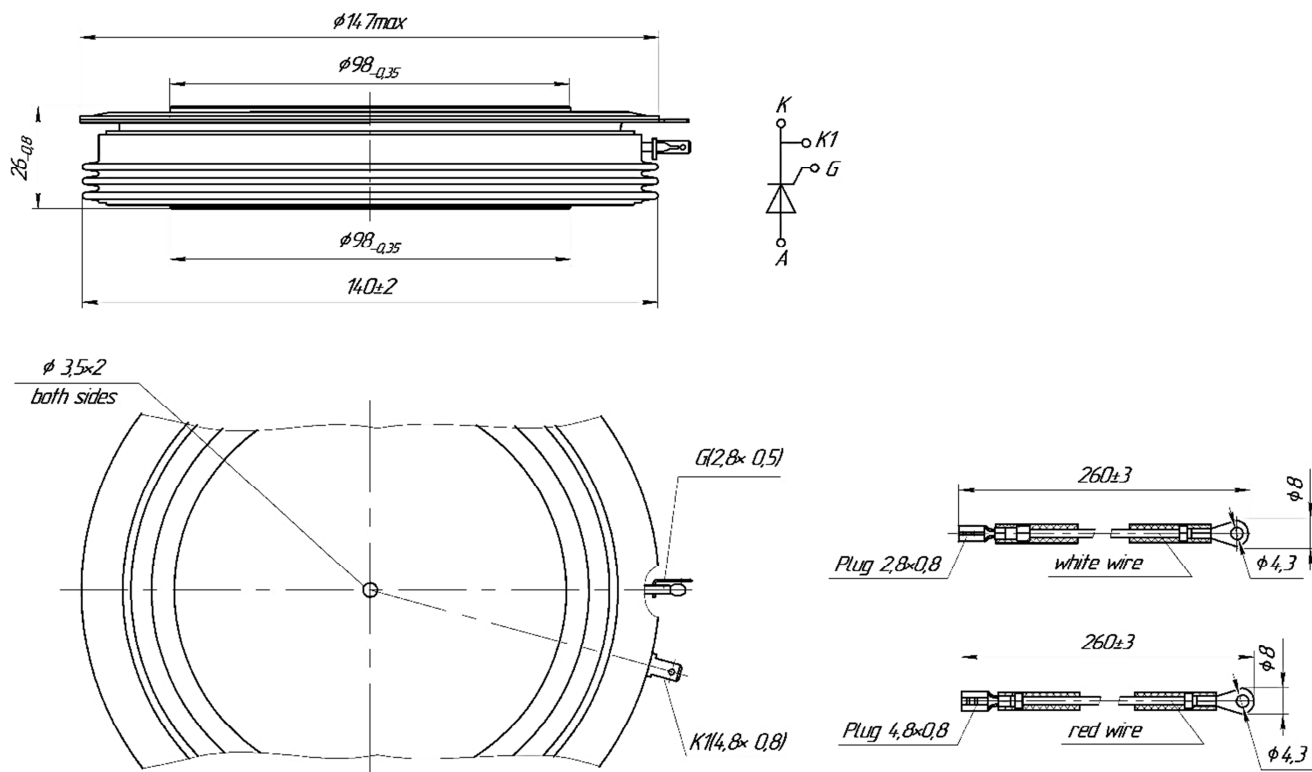

Device Outline Drawing
(dimensions in mm)



126, Proletarskaya str.,
430001, Saransk, Republic Mordovia, Russia
Tel: +7(8342) 47-04-30
Tel/Fax: +7 (8342) 47-15-01
E-mail: vpruvs@elvpr.ru
Internet: www.elvpr.ru